



RF-603 II

Wireless Flash Trigger

无线引闪器

User Manual
使用手册

Contents

Thank you for purchasing YongNuo products in advance.

Please read this user manual carefully and learn how to use camera and flash before.

This product is a wireless transceiver integrated design, for the convenience of description, the product will be named "transmitter" when mounted on the camera hot shoe in some cases, while named "receiver" when mounted or connected to the flash.

General description	1
Cautions.	2
Include items/Optional Accessories	3
The name of each part for RF-603 II	4
Preparation before using	5-7
Wireless flash trigger awaken & testing	8
Wired/wireless remote shutter release	9
Function extend	10-11
Troubleshooting.	12
Specification	13

General description

- RF-603 II adopts a global free FSK 2.4GHz wireless channel which can be suitable in many countries. RF-603 II with FSK system, can be more effective to guarantee speed, distance and stability. Within capacious areas, the remote control distance may reach to 100m, and suitable for RF-603I.
- RF-603 II wireless flash trigger kit is formed by two same transceivers. It can be set to single transmit state (TX), which will be more convenient for testing flash, and can be set to transceiver state (TRX), automatically switch transmit and receive state, **adopts 2 levers button design , it will realize the awakening, flash testing, focus and shutter function in "TX" and "TRX" state respectively.**
- **Transmitter supports single contact triggering**, supports wireless wakening up and triggering the flash through the camera hot shoe, with PC sync cable (optional) can be trigger studio lights, with specially camera shutter connecting cable can realize wired / wireless shutter release remote control, supports controlling multiple cameras and flashes at the same time.
- The highest flash sync speed up to 1/320 second (some of models may only reach to 1/250s or less, difference combination of models of flash and camera using may achieved difference flash sync speed).

Cautions

1. As this is an electronic product accessory, some of the environment causes may affect the working. However this is hardly ever to get this situation, don't worry.
2. Do not pull the wires and turn off the camera when connecting.
3. For a long time non-use, please turn the transceiver off and remove the batteries.
4. Do not put it in high temperature, such as a closed car under direct sunlight, the control panel and other high temperature areas.
5. Keep dry, do not use wet hands contact with the product, the product must not be immersed in water or exposed to rain, and this may and this may lead to not work properly.
6. Do not used in the flammable occasion in violation of this warning may cause an explosion or fire.
7. Owing to this product include battery, please operate it strictly according to related rules, otherwise maybe cause explosion, fire or physical injury.
8. Do not trigger the flash close to a person's eyes, it may impair the person's vision.

Include items/Optional Accessories

Include items:

- RF-603C II or RF-603N II . X2
- LS-2.5 Shutter Cable* . . . X1
- User Manual X1



*Shutter Cable shown according to the packaging.

Optional Accessories:

1. The LS-PC series flash cable

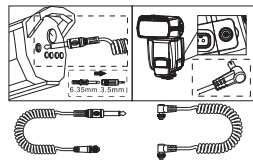

LS-PC635 LS-PC/PC

2. The LS-2.5 series shutter connecting cable

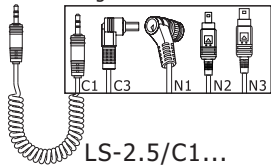

LS-2.5/C1...

C1	Canon 60D/350D/450D/500D/550D/600D/650D/700D Pentax Series
C3	Canon 1D/5D/7D/10D/20D/30D/40D/50D
N1	Nikon D1/D2/D3/D4 Series D200/D300 D700/D800
N2	Nikon D70/D70S/D80
N3	Nikon D90/D600 D3000/D5000 Series D7000 Series

You can additionally purchase the shutter cable or PC sync cable if needed.

The name of each parts of RF-603 II

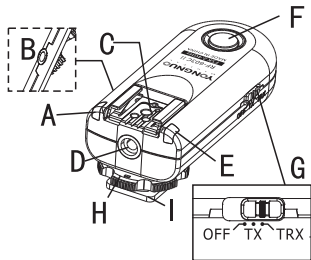

- A: Focusing indicator light (green) / Shutter indicator light (red)
- B: 2.5mm shutter remote cable socket
- C: Hot shoe / Hot shoe contacts
- D: PC socket(output)
- E: Awakening indicator light (green) / Flash trigger indicator light (red)
- F: Multifunction button

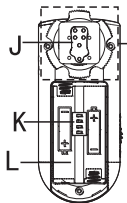

The RF-603C II is more suitable for Canon cameras.

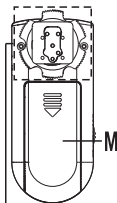

The RF-603N II is more suitable for Nikon cameras.

- G: Power switch-1. TX(transmit)
2. TRX(transmit-receive)
- H: Locking ring
- I: Hot shoe mounting foot
- J: Contacts
- K: Channel setting switch
- L: Battery room
- M: Battery door

Preparation before using

1.Channel Setting:

Use the channel setting switch to set the transceivers to the same code, total 16 channels.

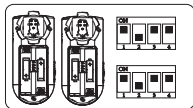

2.Battery Installation:

Slide to open the battery room, install two AAA batteries(not include) for two transceiver according to the "+/-" marks shown.

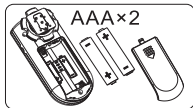

3.Fix the transceiver on the camera hot shoe:

Mount the transceiver on the hot shoe of the camera by hot shoe mounting foot, then tight the locking screw.

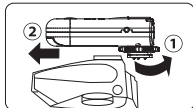

- Support installing the flash on the transceiver (The On-Top Flash,as the picture shown).

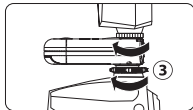

Preparation before using

4. Fix the transceiver on light stand or flash bracket :

Mount the transceiver on the mini stand of the flash attached or other fixed device (not included), and tight the locking screw.

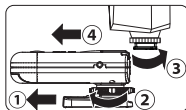

5. Fix the flash on transceiver:

Install the flash on the hot shoe of the transceiver, lock the flash and ensure all links are fixed well.

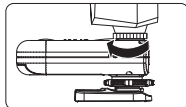

6. Use the PC port to connect other type of flashes :

To realize the function you need to additionally purchase the LS-PC series cable according to the different interface.

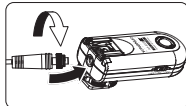

1. Inset the PC cable with the end of nutsert to PC socket of the transceiver, and tight the nutsert.

2. Inset another end of the cable to the synchronous socket of the the flash.

- The PC port just used as output to connect the flash.





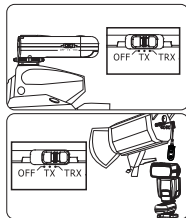

Preparation before using

7. Power Switch and Transmit-receive State Settings:

Set the power switch on TX (single transmit) or TRX (transmit-receive automatic switch) state according to different shooting requirement. When it used as wireless triggering transmitter and flash testing, set to "TX"; while used as wireless triggering receiver, using shutter release or other extended functions, set to "TRX", as the table shown, set to OFF means turn off the power.



Power switch	State	Initialization indicator light	Multifunction button	Function	Indicator light	Diagrams of the indicator light
	TX(single transmit)	The awakening indicator light (Green)extinguish after lighting for 2s.	half press	Awake up the set-top and off-camera flash.	awakening indicator light (Green)	
			full press	Test flash of the set-top and off-camera flash.	trigger indicator light (Red)	
	TRX (Transmit-receive)	After the focusing indicator light (Green) bright for 2s, it will blink each 2s.	half press	Wired/wireless focusing function	focusing indicator light (Green)	
			full press	Wired/wireless shutter function	shutter indicator light (Red)	

Make sure all the transceivers have been fixed before using , the flash need to set to manual "M" mode.

Wireless flash trigger & testing

1. The flash Awakening

Half press the multifunction button of the transmitter or the button of camera shutter, the awakening indicator light of transmitter and receiver will be bright (Green), at the moment if the flash is in dormant state, it will be awakened.

2. Test and trigger the flash

Fully press the multifunction button of transmitter to test the flash once. When fully pressing the release button of camera shutter, it will synchronously trigger the on-top flash and off-camera flash, the flash trigger indicator light of transmitter and receiver will be bright (Red).

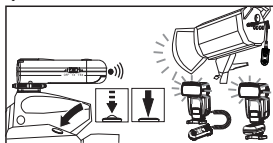
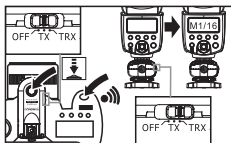

☞ It requires compatible transmitter when using the camera shutter to awake the flash, non specialized transmitter can also wireless trigger the flash normally (single contact trigger).

Wired/wireless remote shutter release function

This product can achieve wired /wireless remote shutter release function, need to LS-2.5 series shutter connecting cable(or purchase) according to the different cameras. When using the shutter release, the power switch need to set in"TRX" state.

1.As the picture shown, use the shutter release between the shutter socket of camera and transceiver.

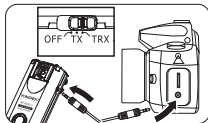

2.Single transceiver can be used as wired shutter release.

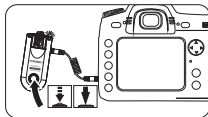

3.When using as a wireless shutter release, fix a transceiver on the camera hot shoe or fix around the camera with the external socket of camera shutter through specialized shutter cable to connect, another transceiver set on hand.

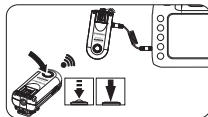

4.Half press the multifunction button of transmitter, the camera will enter into focusing. The Focusing indicator light will bright, fully press the button, the camera will enter into shooting, at the moment, the red shutter indicator light bright.

Function extend

1. Handhold the flash for remote flash trigger sync

Take the RF-603II on the flash as shutter release remote control, LS-2.5mm series shutter connecting cable needs to be used. The transceivers should set in "TRX" state.

1. Install the handhold flash on the hot shoe of the transceiver as transmitter, and lock the flash.
2. Fixed the camera (such as on a tripod), installed the other transceiver on the hot shoe of the camera as receiver, and connected with specialized shutter cable to the external shutter socket of the camera.
3. Press the multifunction button of the transceiver on flash for remote shooting, and the flash will be trigger with shutter synchronously.

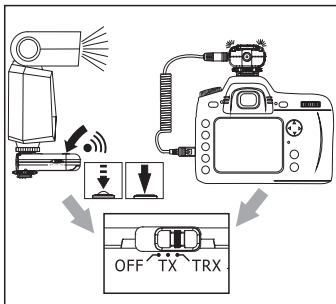

Function extend

2. Remote shooting with flash trigger sync

Examples of using multiple combinations of RF-603II, LS-2.5mm shutter connecting cable needs to be used, and several RF-603II transceivers needs to be purchased.

1. Install one transceiver on the hot shoe of the camera, and connected the shutter socket with the shutter connecting cable to the camera.
2. Install the flash on the hot shoe of the other transceivers, or connect to studio flash lights with PC sync cable.
3. Handhold one transceiver as a remote control transmitter, half press the multifunction button of the transceiver to focus, full press the multifunction button to remote shooting with flashes trigger sync.

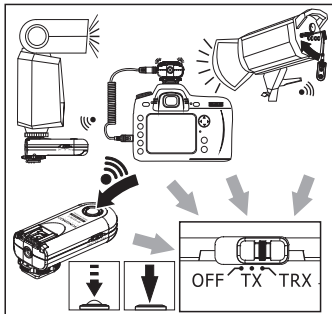

Troubleshooting

1.Unable to test the flash or wireless trigger the flash

- ☞ Make sure the battery is full and the transceivers are in the same channel.
- ☞ Set the power switch of transmitter to TX state then test the flash, it could not test flash when setting to TRX state.
- ☞ Make sure the flash have been prepared and set to manual "M" mode.
- ☞ The poor contact between transmitter, camera and flash will cause the triggering problem, ensure the contacts are clean and have been installed to the correct position.

2.Unable to awake the flash

- ☞ When using the non specialized transmitter, it need to half press the button of transmitter to awake the flash when the transmitter set in TX state. If the flash could not be awoken, it need to manual awake the flash or turn off the power saving mode.

3.The shutter could not be released

- ☞ When part of the cameras could not find the focus, it could not proceed to shoot even if receiving the shooting signal. The focus mode of camera should be adjusted to "M".

Specification

Type: FSK 2.4GHz wireless remote control system

Transmission distance: 100m

Channels: 16 channels

Shutter release: half-press, full-press

Shutter interface: 2.5mm socket

Studio flash light interface: standard PC socket

Max Sync Speed: 1/320 second

Battery: AAA×2(3V)

Stand-by time: about 400 hours in TX state, about 45 hours in TRX mode.

Size (W x H x D): 38MM x 88MM x 33.5MM

The functions of this user manual are based on test conditions of our company. Further notice will not be given if the design and specifications change.

The YONGNUO logo in this manual includes the registered trademark or trademark of Shenzhen Yongnuo Photography Equipment Co.,Ltd in China or/and other countries(regions). All other trademarks are the property of their respective owners.

序列号
SN. _____

产品名称 _____ 购买日期 _____
Product Model _____ Purchase Date _____

用户名称 _____ 联系电话 _____
Name _____ Phone _____

地址 _____ 邮编 _____
Address _____ Zip Code _____

故障说明 _____
Failure Description _____

深圳市永诺摄影器材股份有限公司

地址:深圳市华强北路赛格科技园二栋西A511室

售后服务: 400-001-3888

TEL:(86) 755-837-62448

Website:www.hkyongnuo.com

Email: service@hkyongnuo.com